



Treatment Tables

Introduction

Chattanooga is the world's largest manufacturer of rehabilitation equipment for treating musculoskeletal, neurological and soft tissue disorders. For over six decades, Chattanooga has set a benchmark for leadership, reliability and excellence. Our products contribute to better treatment outcomes in hospitals, clinics and home settings worldwide. We lead the physiotherapy industry by example and, through continuous innovation, provide real world solutions for clinicians and their patients.

As the world's leading brand in rehabilitation, Chattanooga is sold in over 80 countries worldwide. Chattanooga is directly represented in our key markets but also has long lasting relationships with dedicated distributors in the USA, Canada, Latin America, EMEA and Asia Pacific. Our Chattanooga distributors and customers are supported for order placement, training, product delivery and after sales service by a dedicated team of highly skilled DJO employees based all over the world.

Chattanooga is a brand of DJO Global Inc. DJO Global provides solutions for musculoskeletal health, vascular health and pain management. Our products help prevent injuries or rehabilitate after surgery, injury or from degenerative disease, enabling patients to regain or maintain their natural motion.

Visit www.DJOGlobal.eu



Contents

Introduction	1	Montane Alps - 5 Section Table	11
Galaxy Tables	3	Montane Atlas - 3 Section Table	12
Galaxy 5 Section High-Low	4	Montane Tatras/Tatras Gerlach - 2 Section Table	13
Galaxy 4 Section High-Low	5	Montane Dolomites - 2 Section Examination Table	14
Galaxy 3 Section High-Low	6	Montane Taurus Bobath Table	15
Galaxy 2 Section High-Low Head	7	Montane Columbia Fixed Table	16
Galaxy 2 Section High-Low Back	8	Accessories	17
Montane Tables	9		
Montane Andes - 7 Section Table	10		



Treatment Tables

The foundation for any musculoskeletal assessment and treatment is the treatment table. It is also one of the most significant and long standing investments the practitioner will make. The treatment table is one of the foundations of the clinic's style and helps define the atmosphere of the practice. With more than 60 years experience in the rehabilitation arena, Chattanooga remains the practitioner's partner in design and equipment. Chattanooga is proud to present our new and expanded line of treatment tables, offering a broader range of products and price options. From multi-section tables, Bobath treatment tables, to a solid fixed table and offers the practitioner real table solutions.

Galaxy Tables

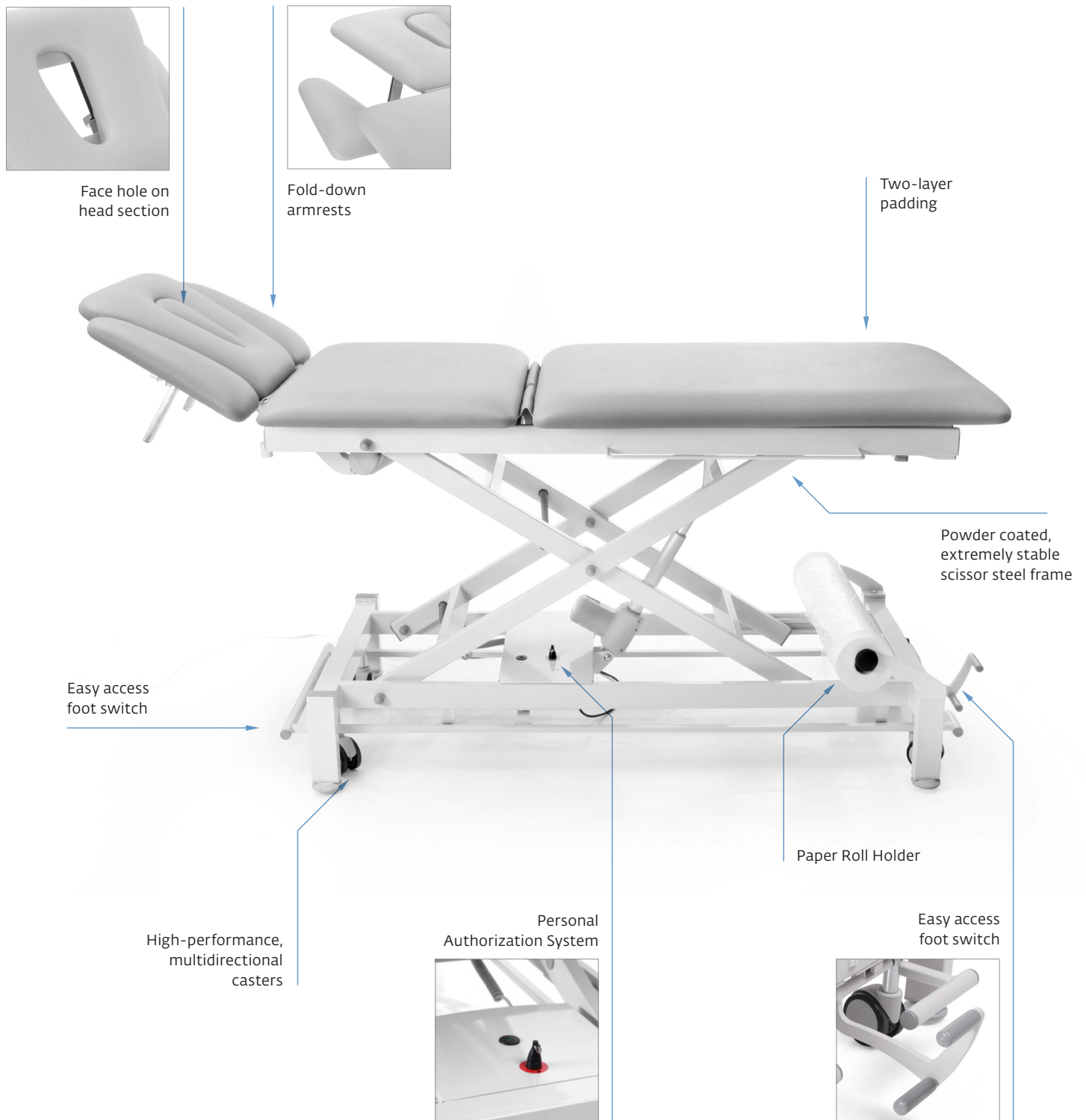

Your table is the core of your practice, and with Chattanooga, you have a trusted partner. Every detail of the Galaxy Table range has been designed, engineered and crafted to elegant, exacting standards, delivering a refined experience that maximizes patient comfort while optimizing practitioner access and ease of operation.

Galaxy Tables provide a strong, reliable, stylish and comfortable addition to your clinic. Their slim compact design allows easy access to patients and the scissor lifting frame ensures Galaxy's minimal footprint even when raising patients. Powerful Hallotronic® actuators deliver the strength to lift the heaviest of patients, while the optional hydraulic actuation system gives the choice of complete wireless freedom.

Galaxy 5 Section High-Low



Product features:

- Fold-down armrests in head section
- Adjustable head section from +40 to -70 with gas spring
- Easy access foot switch, accessible from any position around the table 360°, for simple height adjustment
- Face hole on head section with removable face hole cover
- Adjustable leg section from 0 to 90 with gas spring
- Two-layer padding with non-flammable, bio-compatible and scratch resistant upholstery in many colours
- Powder coated, extremely stable scissor steel frame
- 2 side brackets for fixation of stabilization belts and elastic bands
- Traction support sleeves
- Personal Authorization System with 2 safety magnetic keys
- Hallotronic® System electric high/low height adjustment from 52 to 102 cm
- Non-slip rubber feet with 1 cm height adjustment allowing leveling of the table
- 2 types of frame:
 - 2 small wheels and 2 legs
 - 4 directional castors with central brake and 4 legs

Table Articulations/Dimensions

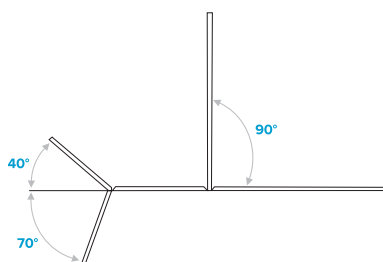
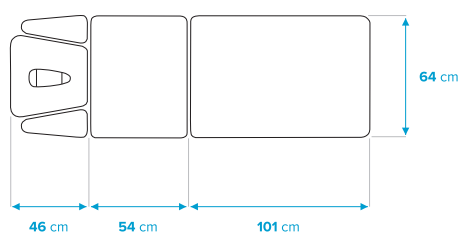

Ordering Information

Part Number Description

Galaxy 5 Section High-Low Treatment Table

3153-x	Galaxy 5 Section Electrical, All-round Switch, Castors
3152-x	Galaxy 5 Section Electrical, All-round Switch
3151-x	Galaxy 5 Section Hydraulic, Castors
3150-x	Galaxy 5 Section Hydraulic

Technical Specifications

Electrical

Mains Power:	100 -240 Volt 50/60 Hz
Standby Consumption:	max. 1 A
Weight:	Standard 92 kg/4 Castors 104 kg
Shipping Weight:	Table Weight + 50 kg
Shipping Dimensions*:	220 cm x 85 cm x 77 cm
Lifting Capacity:	200 kg
Height Adjustment:	52 - 102 cm
Electrical safety class:	Class II, Type B

Hydraulic Pump

Weight:	Standard 93 kg/4 Castors 102 kg
Shipping Weight:	Table Weight + 50 kg
Shipping Dimensions*:	220 cm x 85 cm x 77 cm
Lifting Capacity:	200 kg
Height Adjustment:	51 - 96 cm

Upholstery Color Options

		
Ecru-Crème (x = 00)	Beige (x = 01)	Blue (x = 02)
		
Navy Blue (x = 03)	Terra Cotta (x = 04)	Chocolate (x = 05)
		
Gray (x = 06)	Graphite Gray (x = 07)	Black (x = 08)

NOTICE: Color charts are produced within the limitations of lithographic color printing and are intended as a general guide only.

For ordering purposes, please use model number, hyphen, upholstery color number as indicated in the chart above.

Ordering Information

Part Number Description

Galaxy 4 Section High-Low Treatment Table

3143-x	Galaxy 4 Section Head-Rest, Electrical, All-round Switch, Castors
3142-x	Galaxy 4 Section Head-Rest, Electrical, All-round Switch
3141-x	Galaxy 4 Section Head-Rest, Hydraulic, Castors
3140-x	Galaxy 4 Section Head-Rest, Hydraulic

Technical Specifications









Electrical

Mains Power:	100 -240 Volt 50/60 Hz
Standby Consumption:	max. 1 A
Weight:	Standard 86 kg/4 Castors 98 kg
Shipping Weight:	Table Weight + 50 kg
Shipping Dimensions*:	220 cm x 85 cm x 77 cm
Lifting Capacity:	200 kg
Height Adjustment:	52 - 102 cm
Electrical safety class:	Class II, Type B

Hydraulic Pump

Weight:	Standard 87 kg/4 Castors 96 kg
Shipping Weight:	Table Weight + 50 kg
Shipping Dimensions*:	220 cm x 85 cm x 77 cm
Lifting Capacity:	200 kg
Height Adjustment:	51 - 96 cm

Upholstery Color Options

		
Ecru-Crème (x = 00)	Beige (x = 01)	Blue (x = 02)
		
Navy Blue (x = 03)	Terra Cotta (x = 04)	Chocolate (x = 05)
		
Gray (x = 06)	Graphite Gray (x = 07)	Black (x = 08)

NOTICE: Color charts are produced within the limitations of lithographic color printing and are intended as a general guide only.

For ordering purposes, please use model number, hyphen, upholstery color number as indicated in the chart above.

Galaxy 4 Section High-Low



Product features:

- Fold-down armrests in head section
- Adjustable head section from +40 to -70 with gas spring
- Easy access foot switch, accessible from any position around the table 360°, for simple height adjustment
- Face hole on head section with removable face hole cover
- Two-layer padding with non-flammable, bio-compatible and scratchproof upholstery in many colours
- Powder coated, stable scissor steel frame
- 2 side brackets for fixation of stabilization belts and elastic bands
- Traction support sleeves
- Personal Authorization System with 2 safety magnetic keys
- Hallotronic® System electric high/low height adjustment from 52 to 102 cm with capacity up to 200 kg
- Non-slip rubber feet with 1 cm height adjustment allowing levelling of the table
- 2 types of frame:
 - 2 small wheels and 2 legs
 - 4 directional castors with central brake and 4 legs

Table Articulations/Dimensions

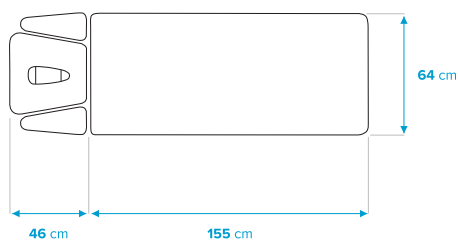

Galaxy 3 Section High-Low



Product features:

- Adjustable head section from +40 to -70 with gas spring
- Easy access foot switch, accessible from any position around the table 360°, for simple height adjustment
- Face hole on head section with removable face hole cover
- Adjustable leg section from 0 to 90 with gas spring
- Two-layer padding with non-flammable, bio-compatible and scratch resistant upholstery in many colours
- Powder coated, extremely stable scissor steel frame
- 2 side brackets for fixation of stabilization belts and elastic bands
- Traction support sleeves
- Personal Authorization System with 2 safety magnetic keys
- Hallotronic® System electric high/low height adjustment from 52 to 102 cm
- Non-slip rubber feet with 1 cm height adjustment allowing leveling of the table
- 2 types of frame:
 - 2 small wheels and 2 legs
 - 4 directional castors with central brake and 4 legs

Table Articulations/Dimensions

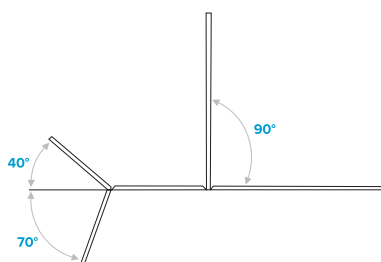
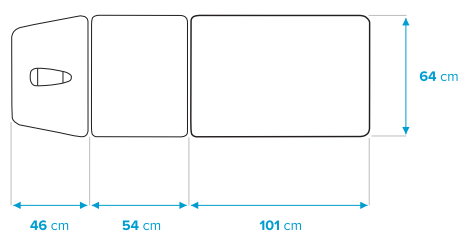

Ordering Information

Part Number Description

Galaxy 3 Section High-Low Treatment Table

3133-x	Galaxy 3 Section Electrical, All-round Switch, Castors
3132-x	Galaxy 3 Section Electrical, All-round Switch
3131-x	Galaxy 3 Section Hydraulic, Castors
3130-x	Galaxy 3 Section Hydraulic

Technical Specifications

Electrical

Mains Power:	100 - 240 Volt 50/60 Hz
Standby Consumption:	max. 1 A
Weight:	Standard 87 kg/4 Castors 99 kg
Shipping Weight:	Table Weight + 50 kg
Shipping Dimensions*:	220 cm x 85 cm x 77 cm
Lifting Capacity:	200 kg
Height Adjustment:	52 - 102 cm
Electrical safety class:	Class II, Type B

Hydraulic Pump

Weight:	Standard 88 kg/4 Castors 97 kg
Shipping Weight:	Table Weight + 50 kg
Shipping Dimensions*:	220 cm x 85 cm x 77 cm
Lifting Capacity:	200 kg
Height Adjustment:	51 - 96 cm

Upholstery Color Options

		
Ecru-Crème (x = 00)	Beige (x = 01)	Blue (x = 02)
		
Navy Blue (x = 03)	Terra Cotta (x = 04)	Chocolate (x = 05)
		
Gray (x = 06)	Graphite Gray (x = 07)	Black (x = 08)

NOTICE: Color charts are produced within the limitations of lithographic color printing and are intended as a general guide only.

For ordering purposes, please use model number, hyphen, upholstery color number as indicated in the chart above.

Ordering Information

Part Number Description

Galaxy 2 Section High-Low Treatment Table

3123-x	Galaxy 2 Section Head-Rest, Electrical, All-round Switch, Castors
3122-x	Galaxy 2 Section Head-Rest, Electrical, All-round Switch
3121-x	Galaxy 2 Section Head-Rest, Hydraulic, Casters
3120-x	Galaxy 2 Section Head-Rest, Hydraulic

Technical Specifications









Electrical

Mains Power:	100 -240 Volt 50/60 Hz
Standby Consumption:	max. 1 A
Weight:	Standard 81 kg/4 Castors 93 kg
Shipping Weight:	Table Weight + 50 kg
Shipping Dimensions*:	220 cm x 85 cm x 77 cm
Lifting Capacity:	200 kg
Height Adjustment:	52 - 102 cm
Electrical safety class:	Class II, Type B

Hydraulic Pump

Weight:	Standard 82 kg/4 Castors 91 kg
Shipping Weight:	Table Weight + 50 kg
Shipping Dimensions*:	220 cm x 85 cm x 77 cm
Lifting Capacity:	200 kg
Height Adjustment:	51 - 96 cm

Upholstery Color Options

		
Ecru-Crème (x = 00)	Beige (x = 01)	Blue (x = 02)
		
Navy Blue (x = 03)	Terra Cotta (x = 04)	Chocolate (x = 05)
		
Gray (x = 06)	Graphite Gray (x = 07)	Black (x = 08)

NOTICE: Color charts are produced within the limitations of lithographic color printing and are intended as a general guide only. For ordering purposes, please use model number, hyphen, upholstery color number as indicated in the chart above.

Galaxy 2 Section High-Low Head



Product features:

- Adjustable head section from +40 to -70 with gas spring
- Face hole on head section with removable face hole cover
- Easy access foot switch, accessible from any position around the table 360°, for simple height adjustment
- Two-layer padding with non-flammable, bio-compatible and scratch resistant upholstery in many colours
- Powder coated, stable scissor steel frame
- 2 side brackets for fixation of stabilization belts and elastic bands
- Traction support sleeves
- Personal Authorization System with 2 safety magnetic keys
- Hallotronic® System electric high/low height adjustment from 52 to 102 cm with capacity up to 200 kg
- Non-slip rubber feet with 1 cm height adjustment allowing leveling of the table
- 2 types of frame:
 - 2 small wheels and 2 legs
 - 4 directional castors with central brake and 4 legs

Table Articulations/Dimensions

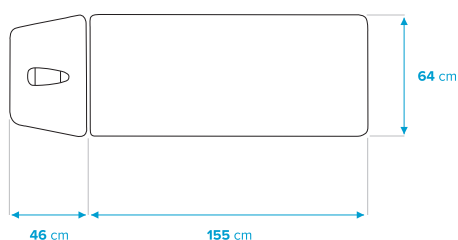

Galaxy 2 Section High-Low Back



Product features:

- 2 section massage and treatment table
- Adjustable back section from 0 to +85 with gas spring
- Face hole on head section with removable face hole cover
- Easy access foot switch, accessible from any position around the table 360°, for simple height adjustment
- Two-layer padding with non-flammable, bio-compatible and scratch resistant upholstery in many colours
- Powder coated, stable scissor steel frame
- 2 side brackets for fixation of stabilization belts and elastic bands
- Traction support sleeves
- Personal Authorization System with 2 safety magnetic keys
- Hallotronic® System electric high/low height adjustment from 52 to 102 cm with capacity up to 200 kg
- Non-slip rubber feet with 1 cm height adjustment allowing levelling of the table
- 2 types of frame:
 - 2 small wheels and 2 legs
 - 4 directional castors with central brake and 4 legs

Table Articulations/Dimensions

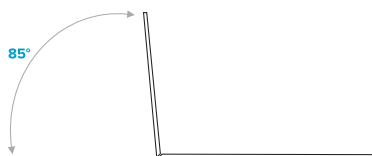
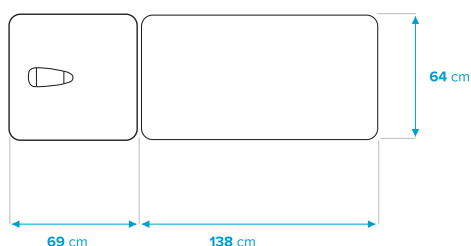

Ordering Information

Part Number Description

Galaxy 2 Section High-Low Back Treatment Table

3127-x	Galaxy 2 Section Back-Rest, Electrical, All-round Switch, Castors
3126-x	Galaxy 2 Section Back-Rest, Electrical, All-round Switch
3125-x	Galaxy 2 Section Back-Rest, Hydraulic, Castors
3124-x	Galaxy 2 Section Back-Rest, Hydraulic

Technical Specifications

Electrical

Mains Power:	100 -240 Volt 50/60 Hz
Standby Consumption:	max. 1 A
Weight:	Standard 93 kg/ 4 Castors 105 kg
Shipping Weight:	Table Weight + 50 kg
Shipping Dimensions*:	220 cm x 85 cm x 77 cm
Lifting Capacity:	200 kg
Height Adjustment:	52 - 102 cm
Electrical safety class:	Class II, Type B

Hydraulic Pump

Weight:	Standard 94 kg/ 4 Castors 103 kg
Shipping Weight:	Table Weight + 50 kg
Shipping Dimensions*:	220 cm x 85 cm x 77 cm
Lifting Capacity:	200 fkg
Height Adjustment:	51 - 96 cm

Upholstery Color Options

		
Ecru-Crème (x = 00)	Beige (x = 01)	Blue (x = 02)
		
Navy Blue (x = 03)	Terra Cotta (x = 04)	Chocolate (x = 05)
		
Gray (x = 06)	Graphite Gray (x = 07)	Black (x = 08)

NOTICE: Color charts are produced within the limitations of lithographic color printing and are intended as a general guide only.

For ordering purposes, please use model number, hyphen, upholstery color number as indicated in the chart above.

Montane Tables



The Montane line is a strong, sturdy, reliable and high quality table that will support your patients and practice for years. With an extensive line of tables available in a range of color options, Chattanooga once again offers the practitioner a broad range of real table solutions.

Robust Mechanical Integrity

- Steel frame provides stability during treatment and also during patient transition to and from the table
- Boomerang mechanism provides a smooth vertical lift
- Gas springs assist table adjustment and prevent sudden movements

Quality Design

- Traditional table designed for stability and patient comfort
- A powerful motor provides fast height adjustment
- Easy access foot switch is accessible from any position around the table, making height adjustment easy and convenient
- One movement engages the wheels to move the table or to stabilize it for treatment

Upholstery

Available in 9 fashion colors to complement a variety of settings from contemporary designer trends to classic clinical settings

Easy Table Movement

Most Montane tables are available with a choice of 4 casters or 2 wheel versions for easy table movement around the clinic. On the optional 4 caster version, one movement engages the wheels to move the table or to stabilize it for treatment.

2 Wheel System



4 Caster System



Montane Andes - 7 Section Table



Features

- 7 section treatment table includes fold down segments in head and chest section
- Electric high/low height adjustment from 49 to 101 cm for easy and safe patient transfer and adjustment to the ideal working height for treatment
- Easy access foot switch, accessible from any position around the table 360°, for simple height adjustment
- Features smooth vertical lift with a capacity up to 150 kg
- Available in 4 casters or 2 wheel versions
- Motorized adjustable middle section with postural drainage model (optional equipment)
- Adjustable head support - positive/negative inclinations
- Face hole on head section with removable cushion
- Side brackets for stabilizing belts are standard equipment

Table Articulations

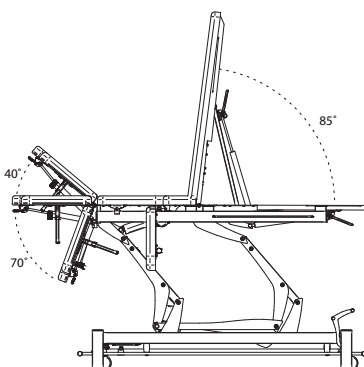
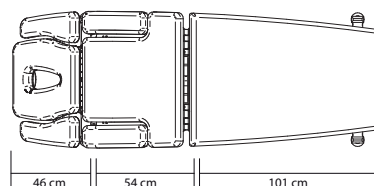
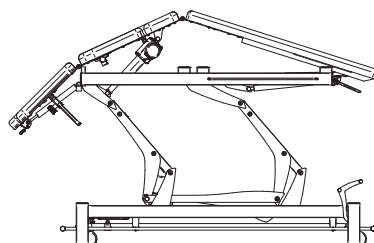

Ordering Information

Part Number	Description
Montane Andes	
3570	Andes 7 Section 120 V - 2 Wheels / 2 Legs
3571	Andes 7 Section 120 V - 4 Wheels
3572	Andes 7 Section 120 V with Postural Drainage - 2 Wheels / 2 Legs
3573	Andes 7 Section 120 V with Postural Drainage - 4 Wheels
3575	Andes 7 Section 230 V - 2 Wheels / 2 Legs
3576	Andes 7 Section 230 V - 4 Wheels
3577	Andes 7 Section 230 V with Postural Drainage - 2 Wheels / 2 Legs
3578	Andes 7 Section 230 V with Postural Drainage - 4 Wheels

Technical Specifications

Mains Power:	230 V / 50 Hz, 120 V / 60 Hz
Standby Consumption:	3,5 W
Input:	230 V / 1.0 A / 50 Hz, 120 V / 1.9 A / 60 Hz
Weight:	110 kg (242 lbs) plus 30 kg pallet when shipping
Dimensions*:	201 x 69 x 49 - 101 cm
Shipping Dimensions*:	219 x 84 x 75 cm
Lifting Capacity:	150 kg (330 lbs)
Electrical Safety Class:	Class II, Type B
Safety Tests:	Meets Directive 93 / 42 / EEC, Certified to CAN/CSA Standard C22.2 No. 601.1-M90X/A2

* Dimensions are listed as L x W x H

Upholstery Color Options

Ecru-Crème (x = 00)	Beige (x = 01)	Blue (x = 02)
Navy Blue (x = 03)	Terra Cotta (x = 04)	Chocolate (x = 05)
Gray (x = 06)	Graphite Gray (x = 07)	Black (x = 08)

NOTICE: Color charts are produced within the limitations of lithographic color printing and are intended as a general guide only.

For ordering purposes, please use model number, hyphen, upholstery color number as indicated in the chart above.
Example: Montane Andes 7 Postural Drainage in Chocolate - 3578-05

Montane Alps - 5 Section Table



Ordering Information

Part Number	Description
Montane Alps	
3550	Alps 5 Section 120 V - 2 Wheels / 2 Legs
3551	Alps 5 Section 120 V - 4 Wheels
3552	Alps 5 Section 120 V with Postural Drainage - 2 Wheels / 2 Legs
3553	Alps 5 Section 120 V with Postural Drainage - 4 Wheels
3555	Alps 5 Section 230 V - 2 Wheels / 2 Legs
3556	Alps 5 Section 230 V - 4 Wheels
3557	Alps 5 Section 230 V with Postural Drainage - 2 Wheels / 2 Legs
3558	Alps 5 Section 230 V with Postural Drainage - 4 Wheels

Technical Specifications

Mains Power:	230 V / 50 Hz, 120 V / 60 Hz
Standby Consumption:	3.5 W
Input:	230 V / 1.0 A / 50 Hz, 120 V / 1.9 A / 60 Hz
Weight:	110 kg (242 lbs) plus 30 kg pallet when shipping
Dimensions*:	201 x 69 x 49 - 101 cm
Shipping Dimensions*:	219 x 84 x 75 cm
Lifting Capacity:	150 kg (330 lbs)
Electrical Safety Class:	Class II, Type B
Safety Tests:	Meets Directive 93 / 42 / EEC, Certified to CAN/CSA Standard C22.2 No. 601.1-M90X/A2

* Dimensions are listed as L x W x H

Upholstery Color Options

Ecru-Crème (x = 00)	Beige (x = 01)	Blue (x = 02)
Navy Blue (x = 03)	Terra Cotta (x = 04)	Chocolate (x = 05)
Gray (x = 06)	Graphite Gray (x = 07)	Black (x = 08)

NOTICE: Color charts are produced within the limitations of lithographic color printing and are intended as a general guide only.

For ordering purposes, please use model number, hyphen, upholstery color number as indicated in the chart above.
Example: Montane Andes 7 Postural Drainage in Chocolate - 3578-05



Features

- 5 section treatment table includes fold down segments in head section
- Electric high/low height adjustment from 49 to 101 cm for easy and safe patient transfer and adjustment to the ideal working height for treatment
- Easy access foot switch, accessible from any position around the table 360°, for simple height adjustment
- Features smooth vertical lift with a capacity up to 150 kg
- Available in 4 casters or 2 wheel versions
- Motorized adjustable middle section with postural drainage model (optional equipment)
- Adjustable head support - positive/negative inclinations
- Face hole on head section with removable cushion
- Side brackets for stabilizing belts are standard equipment
- Gas springs assist in the adjustment of head and foot sections

Table Articulations

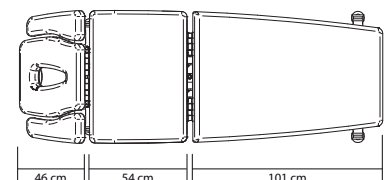
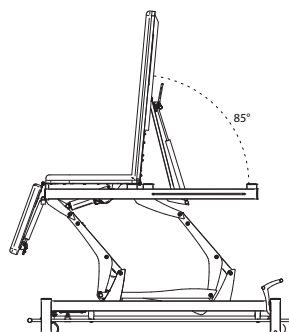
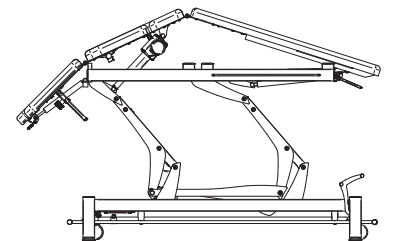
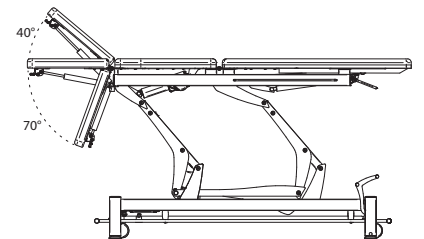

Montane Atlas - 3 Section Table



Features

- 3 section treatment table
- Electric high/low height adjustment from 49 to 101 cm for easy and safe patient transfer and adjustment to the ideal working height for treatment
- Easy access foot switch, accessible from any position around the table 360°, for simple height adjustment
- Features smooth vertical lift with a capacity up to 150 kg
- Available in 4 casters or 2 wheel versions
- Motorized adjustable middle section with postural drainage model (optional equipment)
- Adjustable head support - positive/negative inclinations
- Face hole on head section with removable cushion
- Side brackets for stabilizing belts are standard equipment
- Gas Springs assist in the adjustment of head and foot sections

Table Articulations

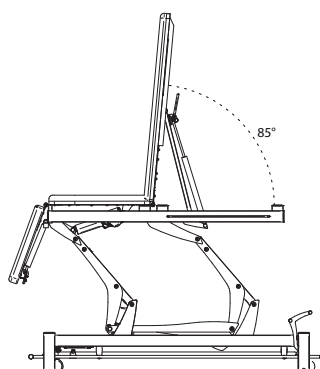
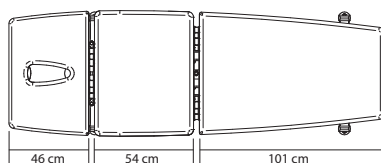
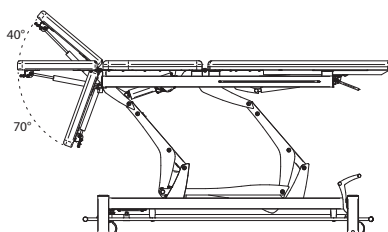

Ordering Information

Part Number	Description
Montane Atlas	
3530	Atlas 3 Section 120 V - 2 Wheels / 2 Legs
3531	Atlas 3 Section 120 V - 4 Wheels
3532	Atlas 3 Section 120 V with Postural Drainage - 2 Wheels / 2 Legs
3533	Atlas 3 Section 120 V with Postural Drainage - 4 Wheels
3535	Atlas 3 Section 230 V - 2 Wheels / 2 Legs
3536	Atlas 3 Section 230 V - 4 Wheels
3537	Atlas 3 Section 230 V with Postural Drainage - 2 Wheels / 2 Legs
3538	Atlas 3 Section 230 V with Postural Drainage - 4 Wheels

Technical Specifications

Mains Power:	230 V / 50 Hz, 120 V / 60 Hz
Standby Consumption:	3,5 W
Input:	230 V / 1.0 A / 50 Hz, 120 V / 1.9 A / 60 Hz
Weight:	110 kg (242 lbs) plus 30 kg pallet when shipping
Dimensions*:	201 x 69 x 49 - 101 cm
Shipping Dimensions*:	219 x 84 x 75 cm
Lifting Capacity:	150 kg (330 lbs)
Electrical Safety Class:	Class II, Type B
Safety Tests:	Meets Directive 93 / 42 / EEC, Certified to CAN/CSA Standard C22.2 No. 601.1-M90X/A2

* Dimensions are listed as L x W x H

Upholstery Color Options

Ecru-Crème (x = 00)	Beige (x = 01)	Blue (x = 02)
Navy Blue (x = 03)	Terra Cotta (x = 04)	Chocolate (x = 05)
Gray (x = 06)	Graphite Gray (x = 07)	Black (x = 08)

NOTICE: Color charts are produced within the limitations of lithographic color printing and are intended as a general guide only.

For ordering purposes, please use model number, hyphen, upholstery color number as indicated in the chart above.
Example: Montane Andes 7 Postural Drainage in Chocolate - 3578-05

Montane Tatras/Tatras Gerlach 2 Section Table



Ordering Information	
Part Number	Description
Montane Tatras - 46cm Head Section	
3520	Tatras 2 Section 120 V - 2 Wheels / 2 Legs
3521	Tatras 2 Section 120 V - 4 Wheels
3522	Tatras 2 Section 230 V - 2 Wheels / 2 Legs
3523	Tatras 2 Section 230 V - 4 Wheels
Montane Tatras Gerlach - 69cm Head Section	
3525	Montane Tatras Gerlach 2 Section 230 V - 4 Wheels

Technical Specifications	
Mains Power:	230 V / 50 Hz, 120 V / 60 Hz
Standby Consumption:	35 W
Input:	230 V / 1.0 A / 50 Hz, 120 V / 1.9 A / 60 Hz
Weight:	110 kg (242 lbs) plus 30 kg pallet when shipping
Dimensions**:	198 x 69 x 49 - 101 cm
Shipping Dimensions**:	219 x 84 x 75 cm
Lifting Capacity:	150 kg (330 lbs)
Electrical Safety Class:	Class II, Type B
Safety Tests:	Meets Directive 93 / 42 / EEC, Certified to CAN/CSA Standard C22.2 No. 601.1-M90x/A2
** Dimensions are listed as L x W x H	

Upholstery Color Options		
Ecu-Crème (x = 00)	Beige (x = 01)	Blue (x = 02)
Navy Blue (x = 03)	Terra Cotta (x = 04)	Chocolate (x = 05)
Gray (x = 06)	Graphite Gray (x = 07)	Black (x = 08)

NOTICE: Color charts are produced within the limitations of lithographic color printing and are intended as a general guide only. For ordering purposes, please use model number, hyphen, upholstery color number as indicated in the chart above. Example: Montane Andes 7 Postural Drainage in Chocolate - 3578-05

Montane Tatras



Montane Tatras Gerlach



Features

- This table is available in 2 configurations - A 46cm head section and a 69cm head section option to satisfy different clinical needs
- Electric high/low height adjustment from 49 to 101 cm for easy and safe patient transfer and adjustment to the ideal working height for treatment
- Easy access foot switch, accessible from any position around the table 360°, for simple height adjustment
- Features smooth vertical lift with a capacity up to 150 kg
- Adjustable head support - positive/negative inclinations
- Face hole on head section with removable cushion
- Side brackets for stabilizing belts are standard equipment

Table Articulations

Montane Tatras

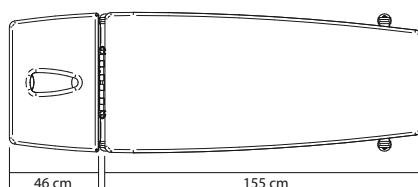

Montane Tatras Gerlach

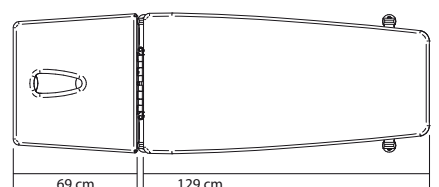

Montane Dolomites 2 Section Examination Table



Features

- 2 section treatment table
- Includes side rails for patient safety
- Electric high/low height adjustment from 49 to 101 cm for easy and safe patient transfer and adjustment to the ideal working height for treatment
- Easy access foot switch, accessible from any position around the table 360°, for simple height adjustment
- Features smooth vertical lift with a capacity up to 150 kg
- Includes simple to use paper roll holder
- Available in 4 casters or 2 wheel versions
- Adjustable head support - positive/negative inclinations
- Face hole on head section with removable cushion
- Side brackets for stabilizing belts are standard equipment
- Gas springs assist in the adjustment of head section

Table Articulations

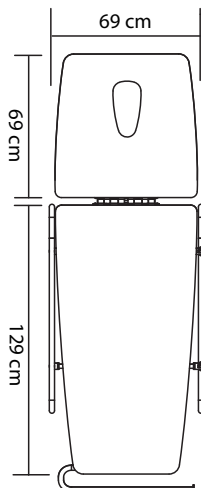
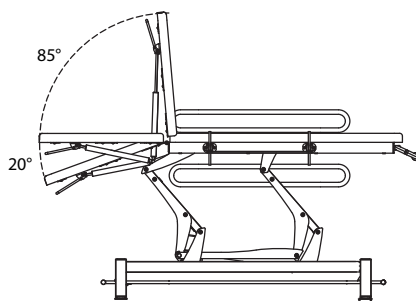

Ordering Information

Part Number **Description**

Montane Dolomites

3590	Dolomites 2 Section 120 V Examination Table with Side Railings and Paper Roll Holder – 2 Wheels / 2 Legs
3591	Dolomites 2 Section 120 V Examination Table with Side Railings and Paper Roll Holder – 4 Wheels
3592	Dolomites 2 Section 230 V Examination Table with Side Railings and Paper Roll Holder – 2 Wheels / 2 Legs
3593	Dolomites 2 Section 230 V Examination Table with Side Railings and Paper Roll Holder – 4 Wheels

Technical Specifications

Mains Power:	230 V / 50 Hz, 120 V / 60 Hz
Standby Consumption:	3.5 W
Input:	230 V / 1.0 A / 50 Hz, 120 V / 1.9 A / 60 Hz
Weight:	110 kg (242 lbs) plus 30 kg pallet when shipping
Dimensions*:	201 x 69 x 49 – 101 cm
Shipping Dimensions*:	219 x 84 x 75 cm
Lifting Capacity:	150 kg (330 lbs)
Electrical Safety Class:	Class II, Type B
Safety Tests:	Meets Directive 93 / 42 / EEC, Certified to CAN/CSA Standard C22.2 No. 601.1-M90x/A2

* Dimensions are listed as L x W x H

Upholstery Color Options

Ecru-Crème (x = 00)	Beige (x = 01)	Blue (x = 02)
Navy Blue (x = 03)	Terra Cotta (x = 04)	Chocolate (x = 05)
Gray (x = 06)	Graphite Gray (x = 07)	Black (x = 08)

NOTICE: Color charts are produced within the limitations of lithographic color printing and are intended as a general guide only.

For ordering purposes, please use model number, hyphen, upholstery color number as indicated in the chart above.
Example: Montane Andes 7 Postural Drainage in Chocolate - 3578-05

Montane Taurus Bobath Tables



Ordering Information	
Part Number	Description
Montane Bobath	
3580	Taurus Bobath 120 V – 1 Section – 4 Wheels
3581	Taurus Bobath 120 V – 2 Section – 4 Wheels
3582	Taurus Bobath 230 V – 1 Section – 4 Wheels
3583	Taurus Bobath 230 V – 2 Section – 4 Wheels

Technical Specifications	
Mains Power:	230 V / 50 Hz, 120 V / 60 Hz
Standby Consumption:	3.5 W
Input:	230 V / 1.0 A / 50 Hz, 120 V / 1.9 A / 60 Hz
Weight:	145 kg (310lbs) plus 50 kg (110 lbs) pallet for shipping
Dimensions*:	201 x 120 x 49 – 101 cm
Shipping Dimensions*:	219 x 134 x 75 cm
Lifting Capacity:	150 kg (330 lbs)
Electrical Safety Class:	Class II, Type B
Safety Tests:	Meets Directive 93 / 42 / EEC, Certified to CAN/CSA Standard C22.2 No. 601.1-M90x/A2
*Dimensions are listed as L x W x H	

Upholstery Color Options		
Ecru-Crème (x = 00)	Beige (x = 01)	Blue (x = 02)
Navy Blue (x = 03)	Terra Cotta (x = 04)	Chocolate (x = 05)
Gray (x = 06)	Graphite Gray (x = 07)	Black (x = 08)

NOTICE: Color charts are produced within the limitations of lithographic color printing and are intended as a general guide only. For ordering purposes, please use model number, hyphen, upholstery color number as indicated in the chart above. Example: Montane Andes 7 Postural Drainage in Chocolate - 3578-05



Features

- 1 and 2 section Bobath treatment table
- Extra wide patient surface and undercarriage
- Electric high/low height adjustment from 49 to 101 cm for easy and safe patient transfer and adjustment to the ideal working height for treatment
- Easy access foot switch, accessible from any position around the table 360°, for simple height adjustment
- Features smooth vertical lift with a capacity up to 150 kg
- Available in 4 casters or 2 wheel versions
- 2 section head support adjusts to 85° positive inclination for treatment
- Gas springs assist in the adjustment of head section

Table Articulations

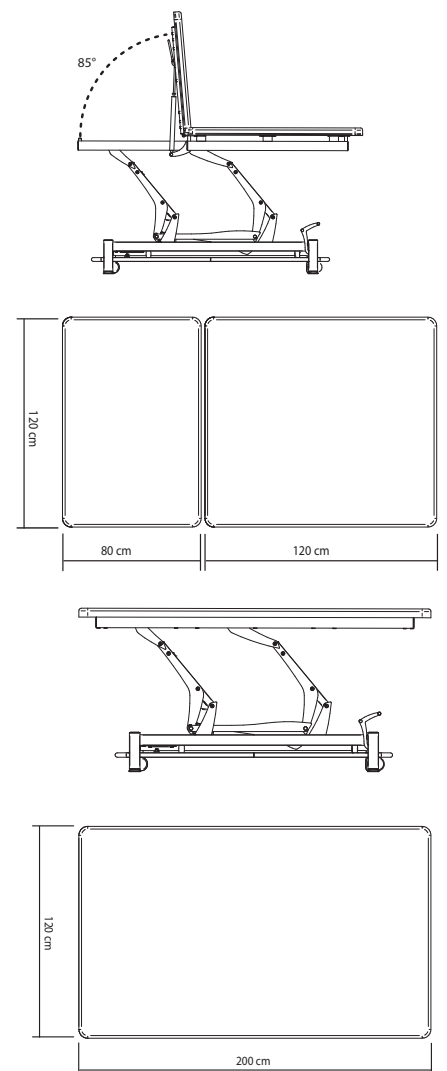

Montane Colombia Fixed Tables



Features

- 2 section fixed table for examination and treatment
- Head section manually adjusts up to a 45° positive inclination
- Solid high-quality fixed table constructed to ensure maximum stability
- Paper roll holder (optional equipment)

Table Articulations

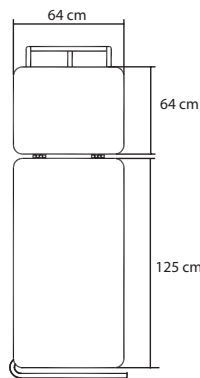
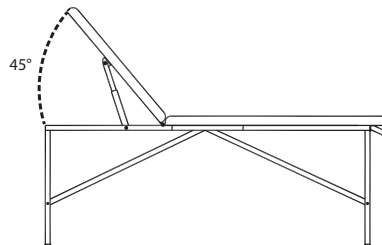

Optional paper roll holder shown

Ordering Information

Part Number	Description
-------------	-------------

Colombia Fixed Tables

3595	Colombia 2 Section Fixed
------	--------------------------

Technical Specifications

Head Angle Adjustment: 0-45°

Maximum Weight Capacity: 150 kg (330 lbs)

Weight: 31 kg (68 lbs)

Dimensions*: 189 x 64 cm

Shipping Dimensions*: 190 x 65 x 15 cm

Capacity: 150 kg (330 lbs)

Paper Roll Holder for use with paper of a maximum width of 60 cm

* Dimensions are listed as L x W x H

Upholstery Color Options



Beige
(x = 01)



Black
(x = 08)

Ordering Information

Part Number	Description
-------------	-------------

A Paper Roll Holder for Galaxy Tables

3110GALXYPPRHLDLR	Paper Roll Holder for the Galaxy Tables
-------------------	---

B Paper Roll Holders for Montane Tables

371007	(B) Paper Roll Holder - Fixed, Gerlach and Examination tables
371008	Paper Roll Holder - Standard High/Low Tables
371009	Paper Roll Holder - High/Low Tables with Postural Drainage
371010	Paper Roll Holder - Universal, Fits in base frame of table (not shown here)

C Traction Supports

3711-xx	Traction Supports (2 pack)
---------	----------------------------

D Stabilization Belt

3712	Stabilization Belt
------	--------------------

E Kaltenborn Wedge

371308	Kaltenborn Wedge
--------	------------------





F Wedge

3714-xx	(F1) Wedge
3715-xx	(F2) Wedge

G Bolster

3716-xx	(G1) Bolster
3717-xx	(G2) Bolster
3718-xx	(G3) Bolster

Upholstery Color Options

		
Ecrú-Crème (x = 00)	Beige (x = 01)	Blue (x = 02)
		
Navy Blue (x = 03)	Terra Cotta (x = 04)	Chocolate (x = 05)
		
Gray (x = 06)	Graphite Gray (x = 07)	Black (x = 08)

Accessories

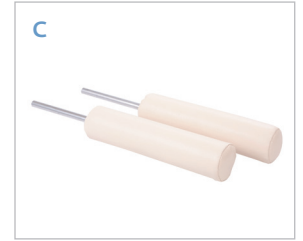
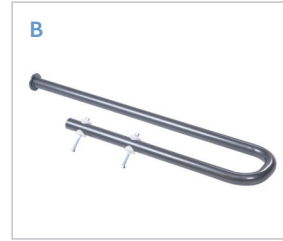
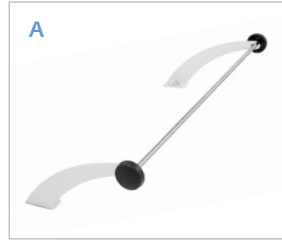

- A** Paper Roll Holder, Galaxy Tables - Holds paper rolls up to 60 cm wide
- B** Paper Roll Holder, Montane Tables - Holds paper rolls up to 60 cm wide
- C** Traction Supports - Mechanical traction supports
- D** Stabilization Belt - Available in black, this stabilization belt attaches to side brackets (available on most models)
- E** Kaltenborn Wedge - For use by professionals trained in manual mobilization techniques.
- F1 & F2** Wedge - Wedges and Bolsters are used to reinforce the correct positioning of the patient during treatment.
- G1, G2 & G3** Bolster

DJO GLOBAL

AUSTRALIA:

T: +1300 66 77 30
F: +1300 66 77 40
E: customerservice.au@DJOglobal.com

BENELUX:

T: Belgium 0800 18 246
T: Netherlands 0800 0229442
T: Luxemburg 8002 27 42
E: benelux.orders@DJOglobal.com

CANADA:

T: +1 1866 866 5031
F: +1 1866 866 5032
E: canada.orders@DJOglobal.com

CHINA:

T: (8621) 6031 9989
F: (8621) 6031 9709
E: information_china@DJOglobal.com

DENMARK, FINLAND, NORWAY & SWEDEN:

T: Sweden 040 39 40 00
T: Norway 8006 1052
T: Finland 0800 114 582
T: Denmark +46 40 39 40 00
E: info.nordic@DJOglobal.com

FRANCE:

T: +33 (0)5 59 52 86 90
F: +33 (0)5 59 52 86 91
E: sce.cial@DJOglobal.com

GERMANY:

T: +49 761 4566 01
F: +49 761 456655 01
E: infoservice@DJOglobal.com

ITALY:

T: +39 02 484 63386
F: +39 02 484 09217
E: vendite@DJOglobal.com

INDIA:

T: +91 44 66915127
E: customercare.india@DJOglobal.com

SOUTH AFRICA:

T: +27 (0) 87 3102480
F: +27 (0) 86 6098891
E: chattanooga.saf@DJOglobal.com

SPAIN:

T: +34 934 803 202
F: +34 934 733 667
E: ventas@DJOglobal.com

SWITZERLAND:

T: +41 (0) 21 695 2360
F: +41 (0) 21 695 2361
E: info@compex.ch

UK & IRELAND:

T: +44 (0)1483 459 659
F: +44 (0)1483 459 470
E: ukorders@DJOglobal.com

UNITED STATES:

T: +1 800 336 6569
F: +1 800 936 6569
E: customercare@DJOglobal.com

DJO GLOBAL, EXPORT CENTRES

ASIA-PACIFIC:

DJO Asia-Pacific Limited
Unit 1905, 19/F, Tower II
Grand Central Plaza
138 Shatin Rural Committee Road
Shatin
HONG KONG
T: +852 3105 2237
F: +852 3105 1444
E: info.asia@DJOglobal.com

EUROPE, MIDDLE EAST & AFRICA:

DJO Benelux
Welvaartstraat 8
2200 Herentals
BELGIUM
T: +32 (0) 14248350
F: +32 (0) 14248358
E: info.emea@DJOglobal.com

LATIN AMERICA:

DJO Global, Inc
1430 Decision Street
Vista
CA 92081-8553
U.S.A.
T: 1 800 336 6569
F: 1 800 936 6569
E: info.latam@DJOglobal.com



MOTION IS MEDICINE⁺